

RECEPTACLE LID  
(PAINTED FRP)

WR-REC-0202 TRASH/PLASTIC &  
GLASS/COMPOST AND  
DRINK CANS OPENING SHOWN  
(SEE PAGE 2 FOR OPTIONS)

APPROVAL:

Signature authorizes Tournesol Siteworks  
to manufacture the product as shown

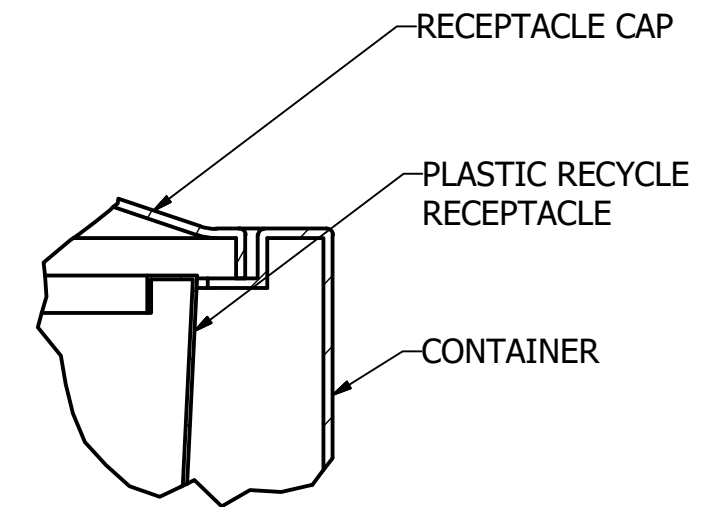
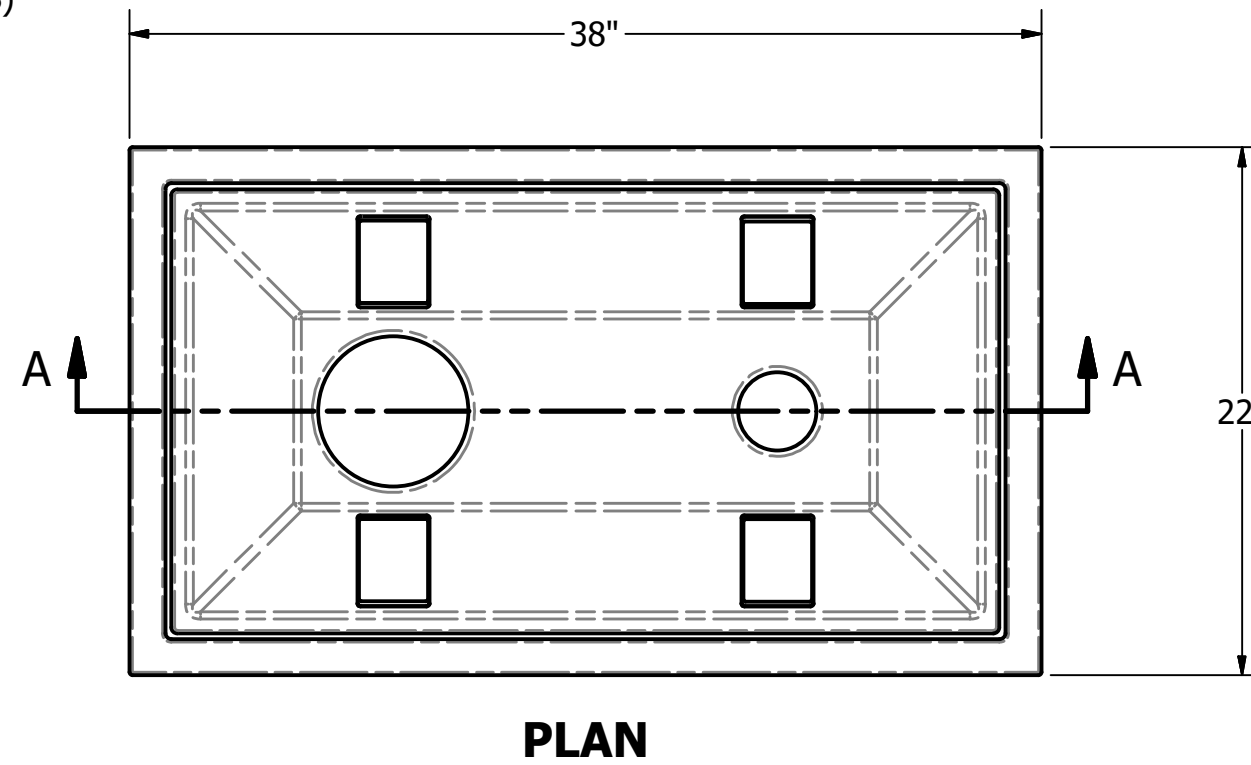

**DETAIL B**

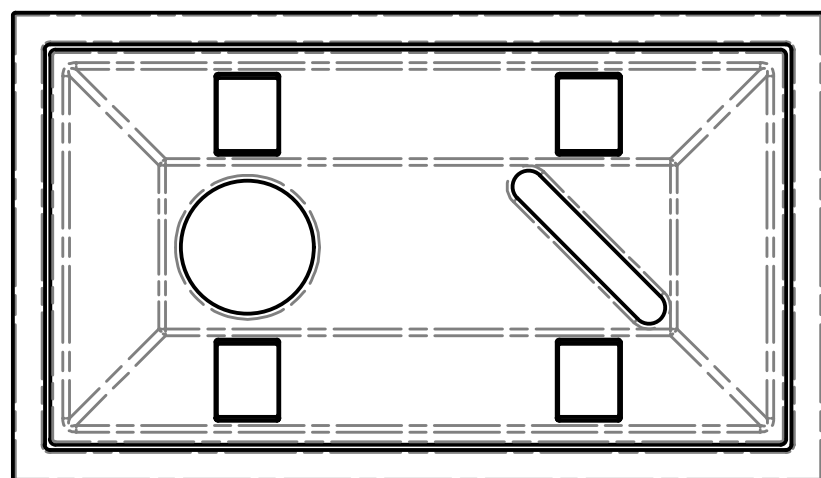

**WR-REC-0201**

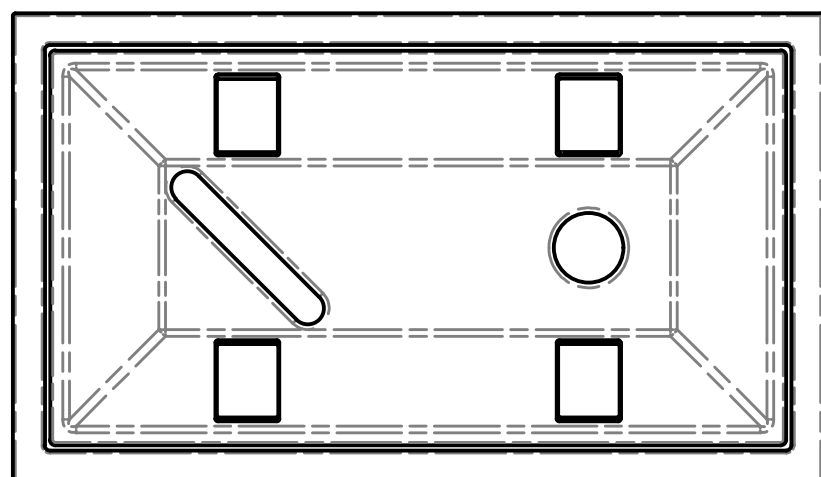

**WR-REC-0203**

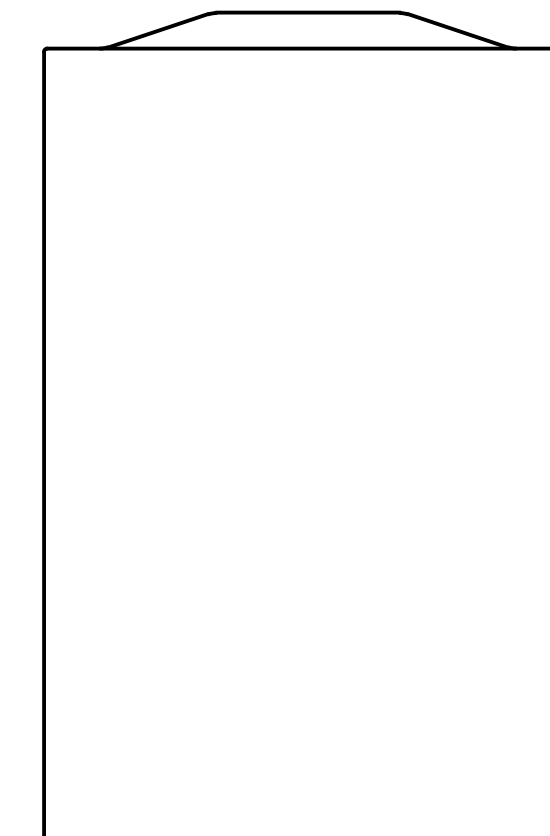
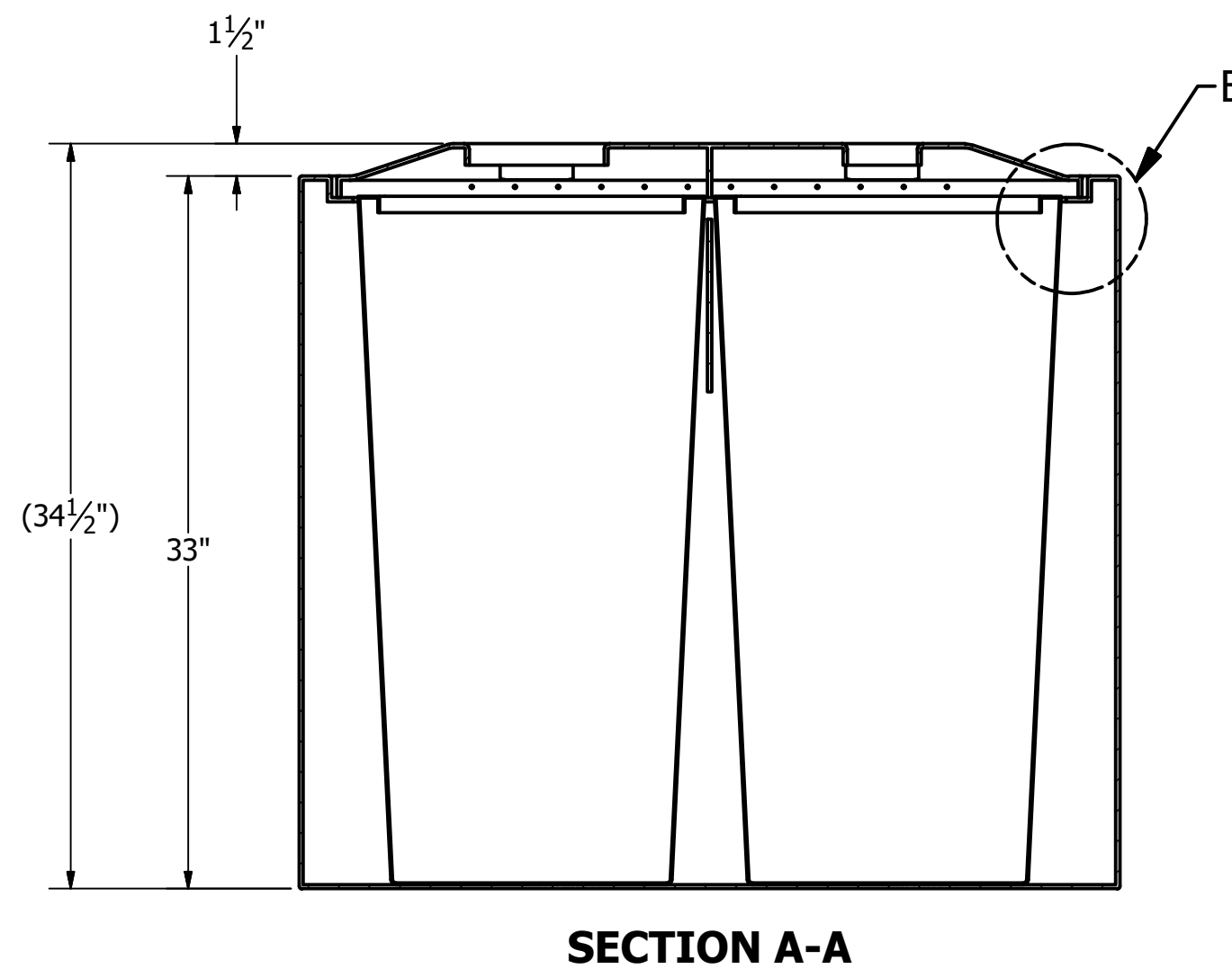

**SIDE**

NOTES: UNLESS OTHERWISE SPECIFIED

- 1) MATERIAL: FIBERGLASS REINFORCED PLASTIC (FRP)  
FOR CONTAINER AND RECEPTACLE CAP  
NOMINAL WALL THICKNESS 1/8" - 3/16"
- 2) ALL DIMENSIONS ARE NOMINAL, ACTUAL SIZE MAY VARY.

COLOR: \_\_\_\_\_

TEXTURE: \_\_\_\_\_

	<b>Tournesol Siteworks</b> 2930 Faber Street, Union City, CA 94587		TITLE
			WR-REC-02XX
DRAWN: MLC	3/8/2018		
SIZE	DWG NO		REV
C	WR-REC-02XX_SUB		B
ALL DIMENSIONS IN INCHES		SCALE 1/8	MATERIAL: SHEET 1 OF 2

APPROVAL:

Signature authorizes Tournesol Siteworks to manufacture the product as shown

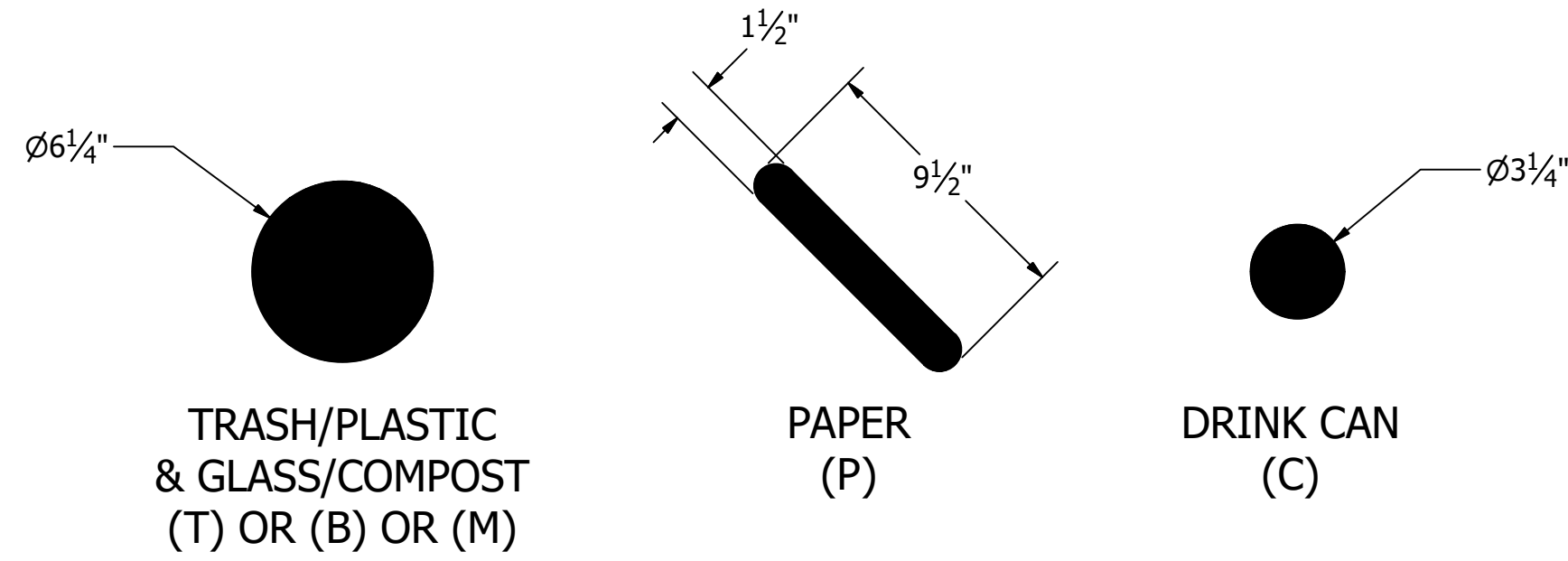

RECEPTACLE OPENING

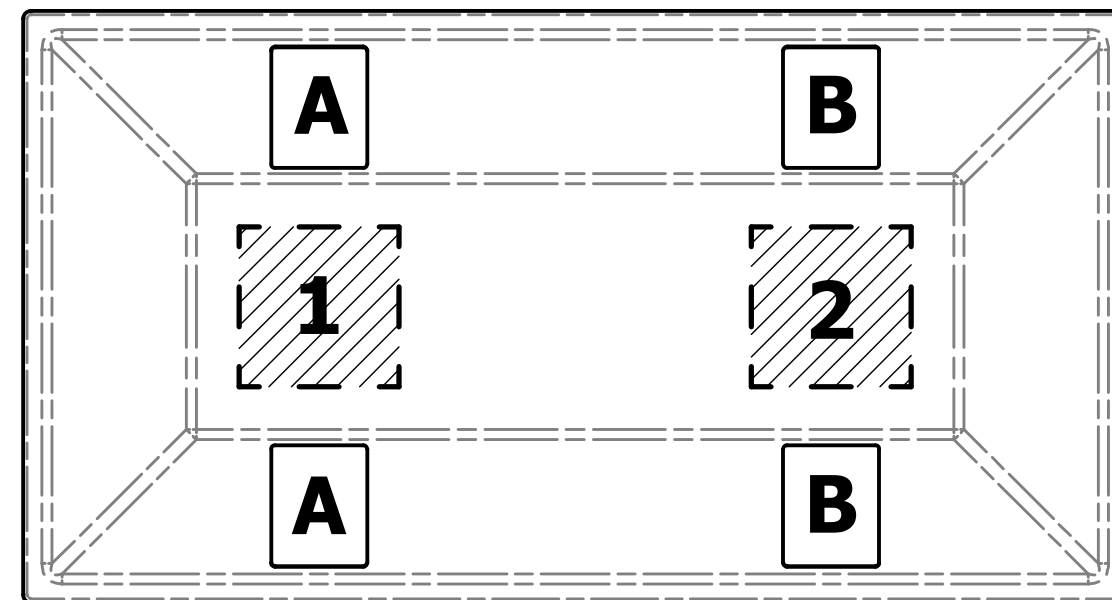

RECEPTACLE DETAILS

(NOTE THE CONFIGURATION FOR YOUR ORDER)

RECEPTACLE OPENING	POSITION 1	POSITION 2
TRASH/PLASTIC & GLASS/COMPOST		
PAPER		
DRINK CAN		
RECEPTACLE LABEL	POSITION A	POSITION B
TRASH		
PLASTIC & GLASS		
DRINK CANS		
PAPER		
RECYCLE		
COMPOST		

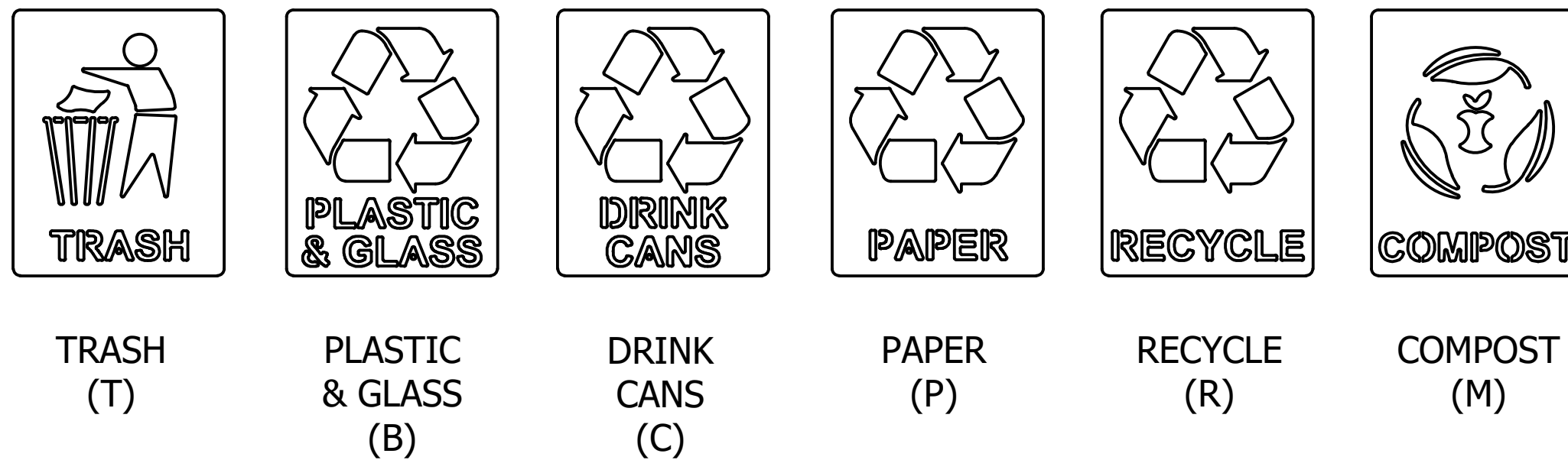

RECEPTACLE LABEL

 <b>Tournesol Siteworks</b> 2930 Faber Street, Union City, CA 94587	TITLE		WR-REC-02XX
	DRAWN: MLC SIZE: C	3/8/2018 DWG NO: WR-REC-02XX_SUB	
ALL DIMENSIONS IN INCHES		SCALE 1/6	MATERIAL: GFRP
			SHEET 2 OF 2