

# CWM Modular Container Irrigation System

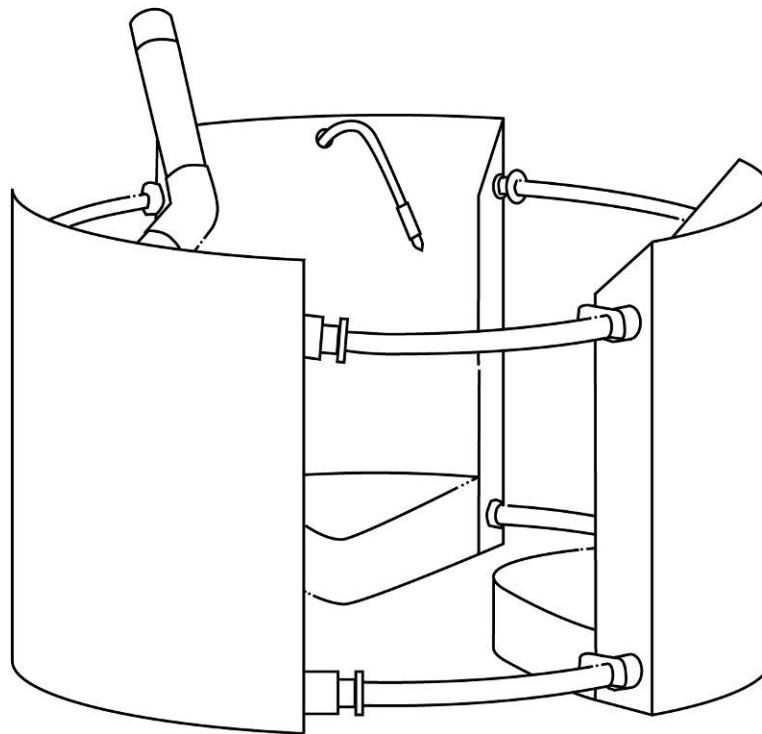

*Installation and Operation Field Manual*

**Tournesol Siteworks LLC**

Hayward, CA  
800.542.2282

[www.tournesolsiteworks.com](http://www.tournesolsiteworks.com)

*Complete Landscape Solutions for the Urban Environment*

# CWM Modular Container Irrigation System

## *Installation & Operation Field Manual*

### Table of Contents

CWM System Contents	3
How CWM Modular Irrigation Works	5
Preparation	6
Assembly	9
Planting	15
Maintenance	20

Should you have specific questions, comments, or recommendations on ways we can meet your needs better as you go through this Installation & Operation Manual, please contact us at 800.542.2282, or email us at [info@tournesolsiteworks.com](mailto:info@tournesolsiteworks.com).

# CWM System Contents

Check system contents prior to beginning assembly. Frequently BioGuard and silicone caulk are packaged separately—check all boxes before starting.

## CWM-XXYY-2k, 3k, 4k, 5k Systems

XX= Module width in inches, YY=height in inches

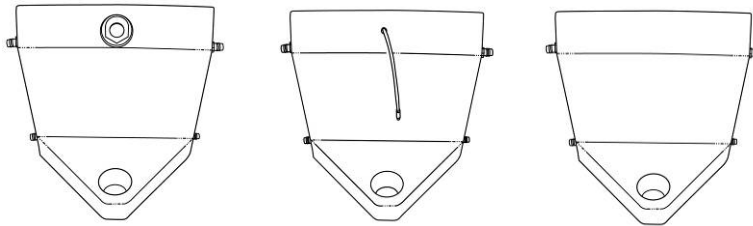

Fill Module  
1 per system

Sensor module  
1 per system

Secondary module  
2k=0, 3k=1, 4k=2,

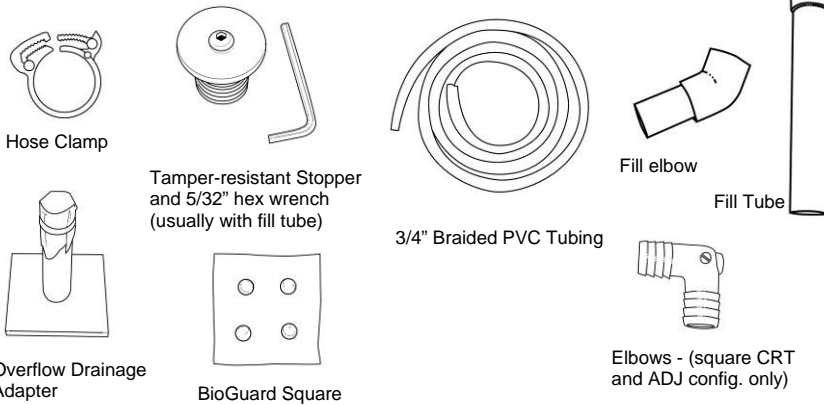

Overflow Drainage Adapter

Tamper-resistant Stopper and 5/32" hex wrench (usually with fill tube)

3/4" Braided PVC Tubing

Fill elbow

Fill Tube

BioGuard Square

Elbows - (square CRT and ADJ config. only)

### CRT Configuration

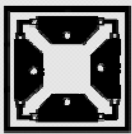

For round, square, or wide rectangular containers, all units have hose barbs on both sides. Square-back systems have elbows included.

### LIN Configuration



For rectangular containers. Two units have plugs on one side, hose barbs on the other, all others have hose barbs.

### ADJ Configuration



For smaller square containers. Both units have plugs on one side, hose barbs on the other. Includes elbows..

## CWM System Contents

Check system contents prior to beginning assembly. Frequently BioGuard and silicone caulk are packaged separately—check all boxes before starting.

### CWM-XXYY-MS (Solo Module Systems)

XX= Module width in inches, YY=height in inches

Solo modules are designed to be used on their own. They have plugs on either side, and have both a sensor tube and fill port.

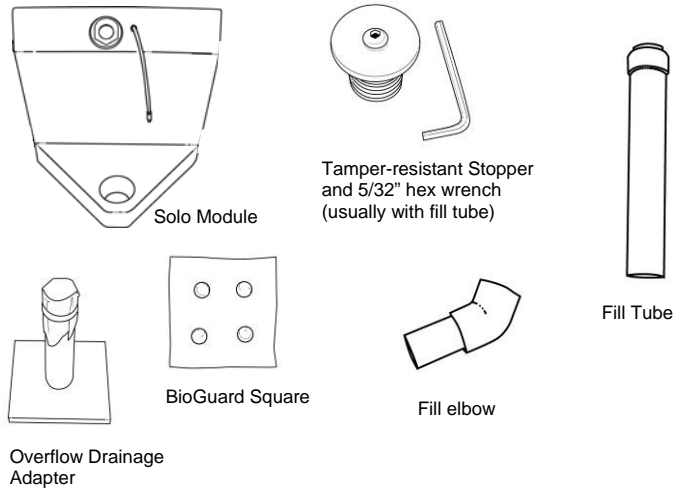

### CWM-XXYY-5kE or CWM-E2400

XX= Module width in inches, YY=height in inches

Because the typical CWM module hugs the wall, extension modules are sometimes needed to get water to the center of a pot or planter. A unit with a front adapter must be ordered to accommodate the extension tube need-

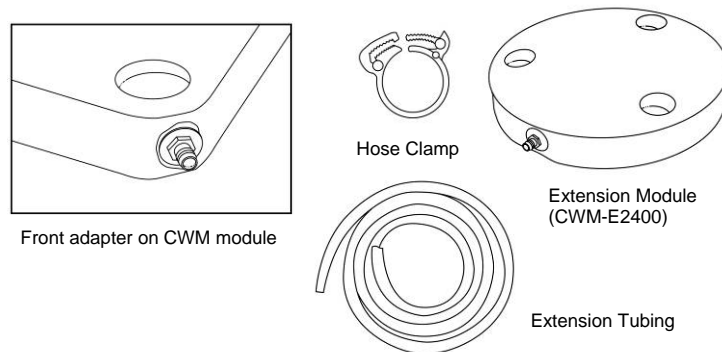

## How the CWM Modular Container Irrigation System works

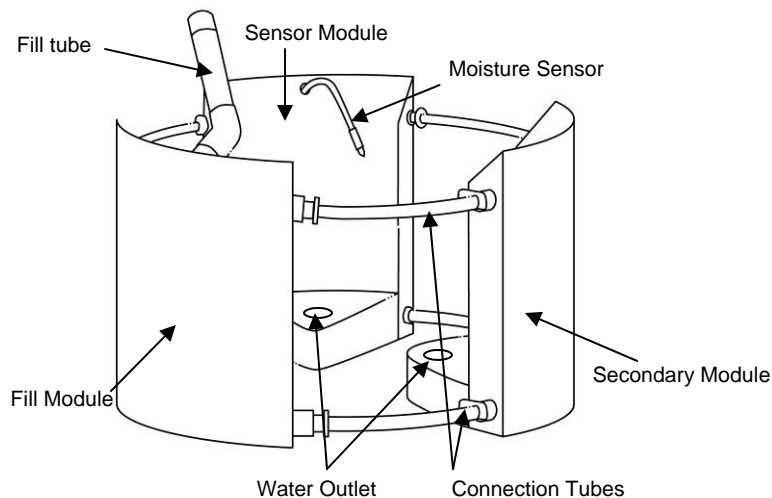

The CWM Modular system is made up of hollow, airtight reservoirs linked together with flexible tubing. They are planted directly into the soil, typically hugging the walls of the pot or planter. They can be used individually, or up to 5 modules per system.

The units are filled through a capped hole at the top of a fill tube, and the water fills all modules through the lower connection tube.

The water in the reservoir flows into the soil through small holes at the bottom of each module (shown as water outlet above). The water wicks its way up through the soil until it reaches the moisture sensor, planted 1/3 to 1/2-way down the container. When moisture reaches the sensor it closes like a valve, preventing air from passing through the tub into the reservoir modules.

A vacuum develops above the water level, preventing more water from flowing into the soil. This vacuum is transmitted between modules by the upper connection tube. As the plants and flowers use the moisture and the soil starts to dry, the sensor tip dries and allows air to pass through the tube. The vacuum above the water is broken, and water can flow to the soil.

The process forms a cycle, interrupted only by the removal of the stopper and the filling of the reservoir. The overflow drainage adapter at the bottom of the container allows excess water that builds up (typically rainwater and irrigation water pulled down by gravity) to escape without disrupting the system.

# Preparation

## What You'll Need



Hacksaw or PVC shear



PVC Glue

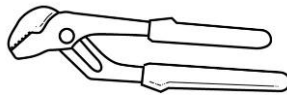

Pliers

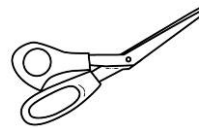

Scissors or utility knife

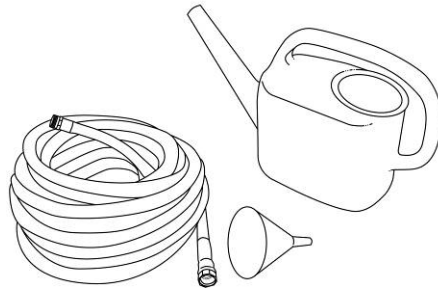

Hose, or watering can and funnel



Trowel or shovel



### Soil

Tournesol Siteworks recommends use of a good grade of soil-less potting mix when using the CWM Modular system. We typically recommend a blend of approx. 1/3 peat, 1/3 composted organics, and 1/3 sand or expanded slate or shale. The mix needs to have good capillary action, but still have enough structure so it doesn't compact and still drains. *Do not use field soil with any pot or container planting!*

# Preparation

## Installation, Drainage Height

The CWM Modular system works best when the top of the bottom projection is **6"-12"** from the bottom of the major root-ball.

The CWM can either be set directly on the bottom of the container, or staged up with soil, gravel or other fill.

Planning for the drainage reservoir created at the bottom of the container is critical at this stage. While the soil will wick the water up, gravity is also pulling it down.

**The top of the drainage adapter should be 1" above the top of the gravel level.** If a longer adapter is needed, 3/4" PVC pipe can be glued, with a union, to the adapter (just slip the fabric off and put it back over the extension). Or, the adapter can be cut down if less water is desired. A lower adapter may result in the unit weeping during normal use.

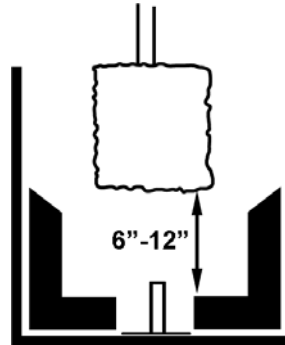

Staging the CWM for deeper tree & underplantings

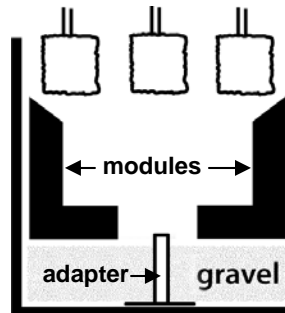

Staging the CWM for shallow plantings - note adapter is above gravel fill level

# Preparation

## Installing the Drainage Adapter

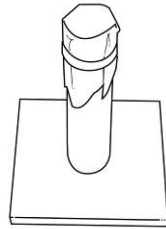

Overflow drainage adapter

***The overflow drainage adapter should only be used with watertight, sealed planters.***

Test adhesive included with system to ensure it is compatible with the waterproofing inside the pot or planter. Apply generous amount to bottom of plate.

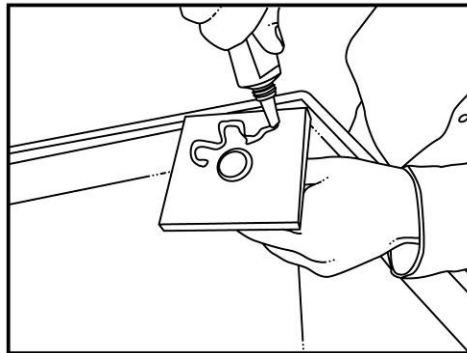

Set adapter directly over drain hole, press firmly to set. Apply a bead of sealant between the plate and the container. Repeat for all drain holes.

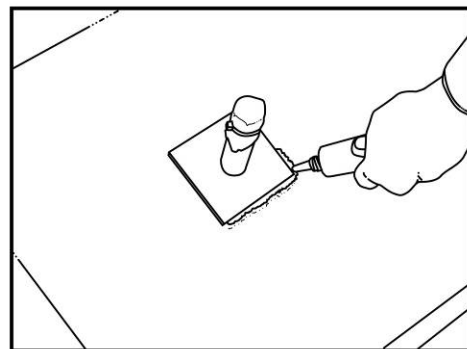



## Preparation

### Backfill Planter

Using soil or gravel, backfill the container to level where CWM Modules will sit. The top of the overflow drainage adapter should be at least 1" above the level of the gravel.

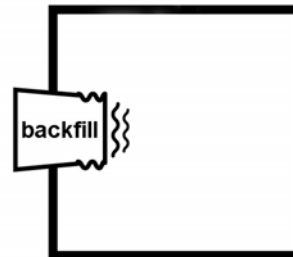

Install soil separator fabric on top of the drainage level, if needed.

### Layout Units, Measure & Cut Tubing

Set units into container to confirm fit and layout. No more than 5 units should be linked. Modules should be level, and of the same height. If possible, sensor module should be separated from fill module by a secondary module. Space modules evenly.

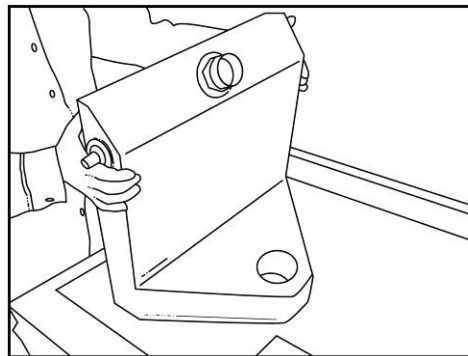

Measure distance between shoulder of hose barbs for tubing. Cut tubing using scissors or utility knife. For curved systems, cut the lengths slightly longer than measured to allow for curve.

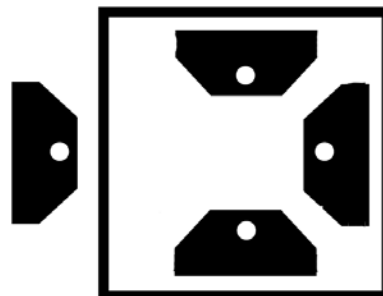

If the system uses an extension module (see p. 14), identify which module has the extension adapter, and lay out how it will connect to the extension module. Measure and cut the connecting tube for the extension at this time as well.

# Assembling the System

## Attach Modules & Tubing

It is usually easier to remove the modules and assemble the system outside of the pot or planter.

Linear (LIN) and Adjacent (ADJ) configurations may often be assembled completely outside container, and slipped inside. Circuit (CRT) systems can be partially assembled as shown.

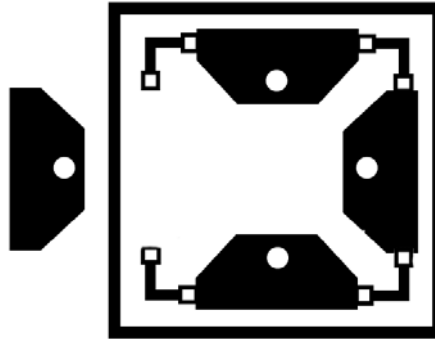

Slide the cut lengths of tubing over the hose barbs, pushing straight on. The tubing will slide over the barb easier if a dab of liquid soap is put on the barb or the tube is softened with hot water..

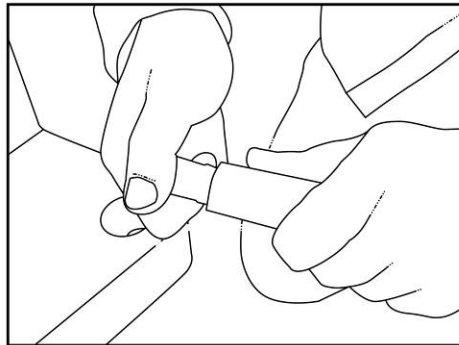

## Assembling the System

### Attach Modules & Tubing (cont.)

Wrap a hose clamp around each barb. If the clamp needs to be removed, push one end back while pulling the other forward.

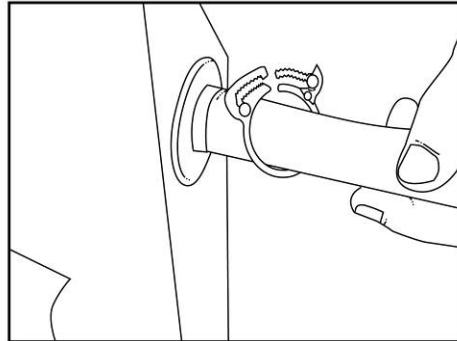

Use a pliers to snap clamps closed - a good seal is critical to ensure an air-tight connection, and the unit's function.

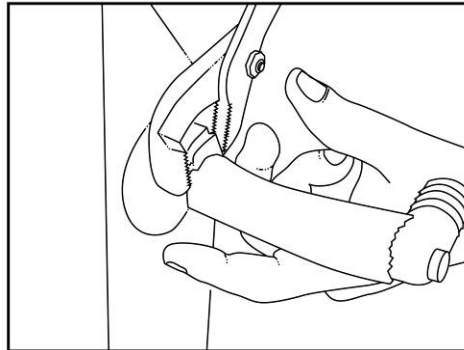

If the system uses an extension module (see p. 14), install the connecting tube on the module with the extension adapter prior to placing the partially assembled unit back on the planter. It will make installation of the extension module easier.

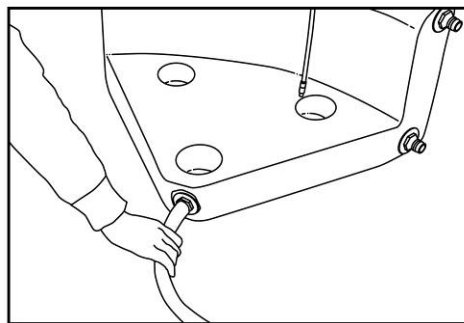

***Set partially assembled unit back into container, and connect the final unit.***

## Assembling the System

### Assembling the Fill Tube

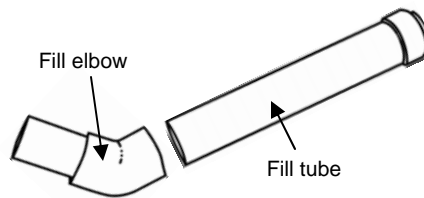

Without gluing or cutting, connect the fill pipe to fill elbow. Push elbow section into male adapter in fill module, then orient at approximately 45° to vertical. This angle allows for easier, faster filling.

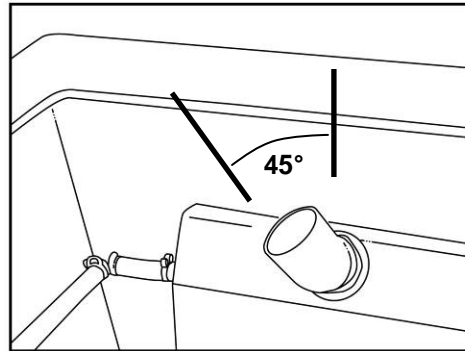

Top of fill tube should extend 1"-3" over the top of the soil level. Determine the correct length of fill elbow and fill pipe. Remove from fill module, and cut to length with hack-saw or PVC cutter.

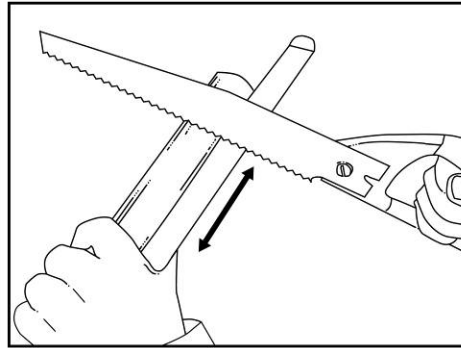

## Assembling the System

### Assembling the Fill Tube (cont.)

Glue fill elbow into male adapter on fill module, then glue the fill tube into the fill elbow, using PVC cement.

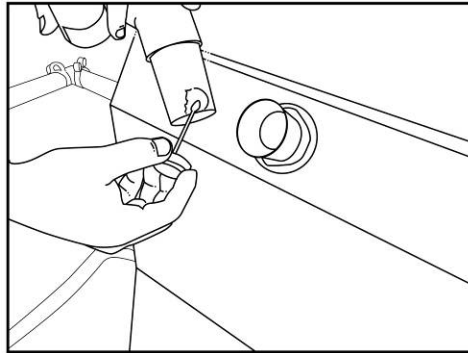

Take this chance to make sure that the Tamper Resistant Stopper and wrench are in place in the top of the fill tube.

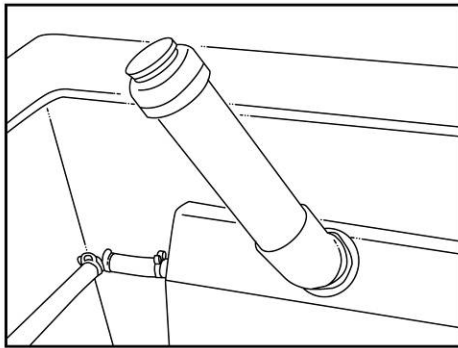

## Assembling the System

### Installing Extension Modules (where applicable)

CWM Modules installed along the perimeter of planters wider than 60" may not provide enough water for the central plantings. By adding one or more extension modules (part. no. CWM-E2400), water can be delivered to larger areas. Typically a CWM system with extension module will have one (or more) modules with and extension adapter pre-installed. This should have already been noted, and the connection tubing installed (see pp. 8 & 10).

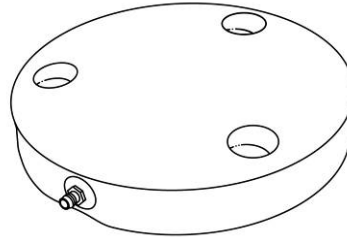

CWM-E2400 Extension Module

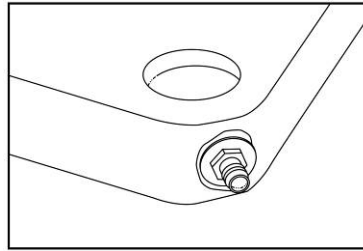

Typical module with extension adapter

The extension module must be located level with the other modules, and the connecting tube shouldn't rise or dip as it runs from the extension adapter to the extension module.

Connect the module, pushing the hose straight over the hose barb.

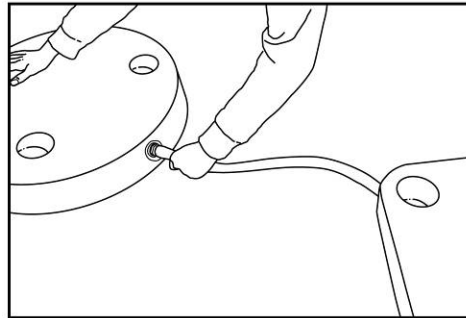

As before, attach hose clamps to both the extension module and the extension adapter, and make sure they are closed tightly with a pliers.

# Planting

## Place Bioguard squares, backfill with soil

Find the BioGuard square bag (a yellow plastic bag), and open it. BioGuard is designed to prevent the roots of the plants from growing into the reservoirs.

Each square is coated with Treflan, so read the label on the bag and use care when handling. Use gloves, and close the bag when finished (the BioGuard can stain items yellow). Place one square in each water inlet cup. It doesn't matter which side goes up.

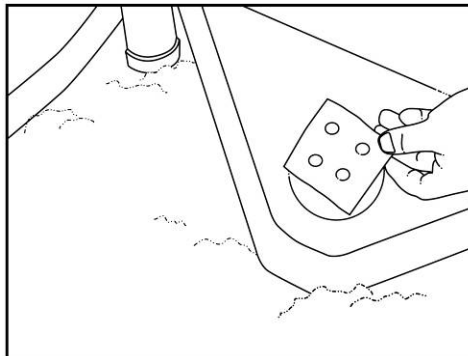
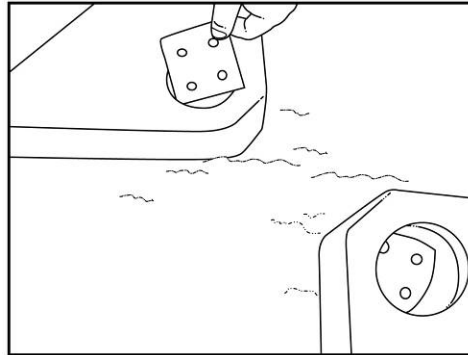

Backfill with soil, up to the level where the main plant will sit. Pack the soil firmly into the cups, and around the CWM Modules. The system functions best when the soil is well packed.

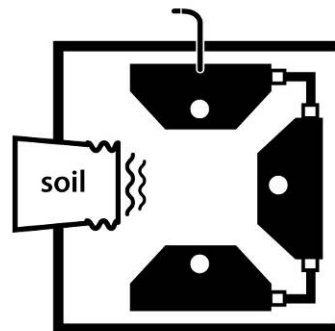

## Planting

Set primary plant, orient as necessary

Remove the primary plant from its nursery pot, box, or wire basket, and place into the container. Be sure to orient the plant at this time, prior to backfilling with more soil.

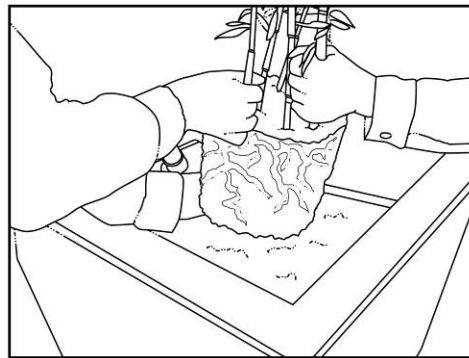

Be sure to orient the plant at this time, prior to backfilling with more soil.

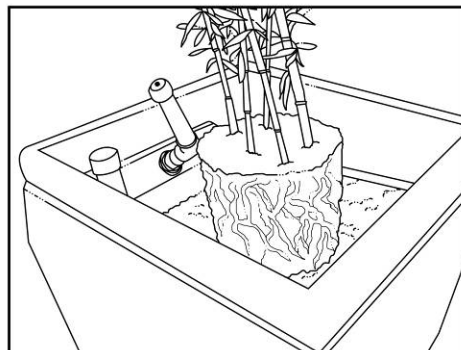



# Planting

## Determine Sensor Height & Location

The moisture sensor is the clear plastic tube with the white tip at the end. The white tip is a microporous plastic that acts as a simple valve.

By adjusting the height of the sensor up and down, you can control how much water is released from the CWM Modular system. ***The lower the sensor, the drier the soil. The higher the sensor the wetter the soil.***

Prior to installation, dip the sensor in a cup of water for 15 sec.

Locate the sensor close to the main plant, approximately 2/3 down the major rootball. The exact orientation of the sensor isn't important, but it is critical that it is well packed into the soil

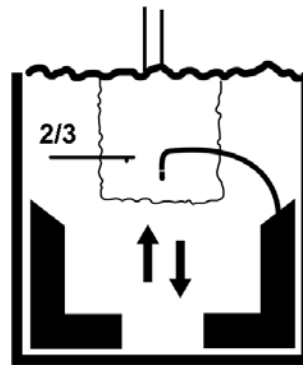

Adjust the moisture level in the container by raising or lowering the height of the sensor

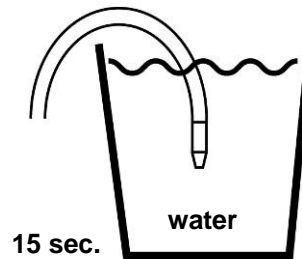

# Planting

## Installing the Moisture Sensor

Backfill the planter with soil up to the level where the sensor will be placed (typically 2/3 down the major rootball).

Dig out a small area near the rootball for the sensor, and insert it into the soil. Back fill with soil, making sure that the white tip of the sensor has good contact with the surrounding soil.

Pack the area around the sensor firmly as you continue to add soil.

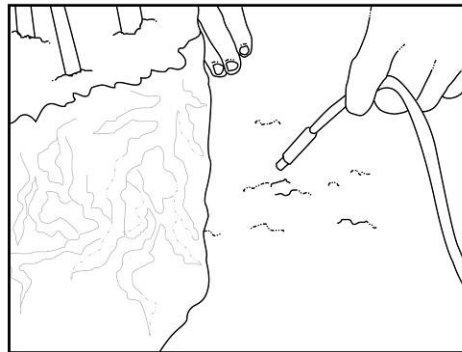

# Planting

## Backfill soil around primary plant

Backfill soil up to the desired planting level. The top of the root ball should not be below the soil level.

Pack the soil firmly throughout. If you can easily stick your fingers into the soil past the second knuckle, keep packing.

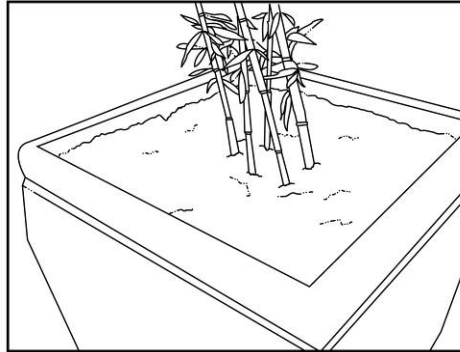

## Place underplantings, pack soil

For best results, start with good size underplantings (1 gal. or 4" jumbo packs). Dig area out for underplantings, place plants and repack soil.

Water the plantings in with a medium amount of water to aid settling.

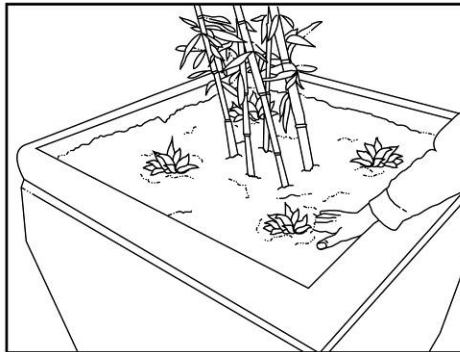

It may take the underplantings some time before their roots reach down to the moisture zone. They may need to be top watered lightly for the first few weeks of maintenance.

## Maintenance

### Filling the reservoir

Fill the system for the first time. The CWM Modular container irrigation system is equipped with a tamper resistant stopper. Because maintaining the vacuum in the reservoir is key to the system's function, it is important to replace and reseal the stopper every time the reservoir is filled.

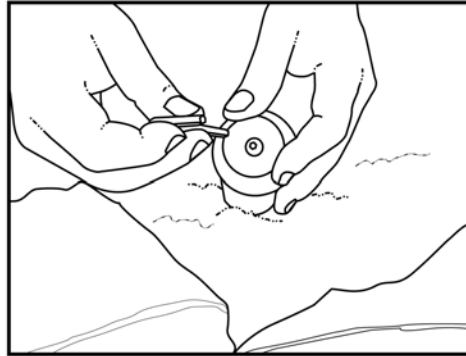

The stopper expands and contracts by turning the hex head bolt in the middle of the stainless washer. To loosen, use the hex wrench and turn the bolt counterclockwise 3 turns. The stopper can then be pulled from the fill tube.

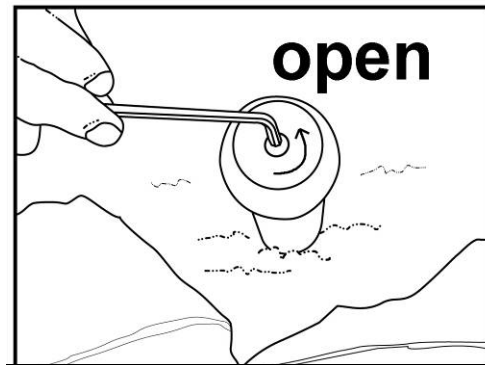

Stick the head of the hose deep down the fill tube for best results. Having a shutoff near the end can prevent messy overspill. If the fill tube has been installed too close to vertical, air may back up in the system and cause irregular filling.

## Maintenance

### Filling the reservoir (cont.)

Fill at a medium rate, to allow the water to transfer between modules.

As you fill, remember that the largest systems may have a substantial water capacity and may take some time to fill.

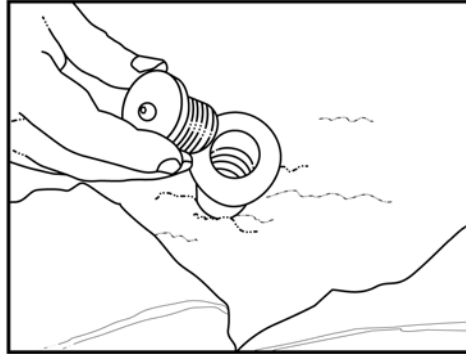

When finished filling, insert the tamper resistant stopper into the fill tube, and tighten the hex bolt 3 turns clockwise. The should be filled no more frequently than necessary.

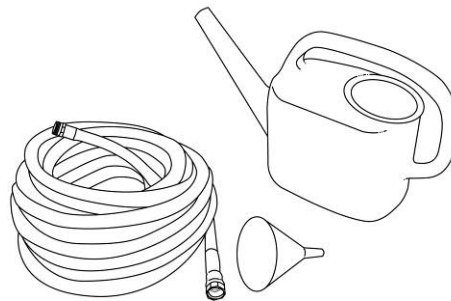
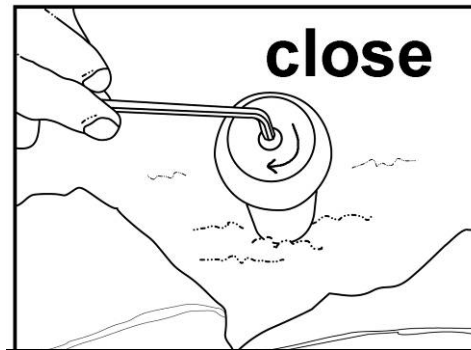

# Maintenance

## Maintaining the CWM Modular System

Filling the reservoir should become part of the regular cycle of plant maintenance. In the initial establishment period, the moisture levels in the soil should be monitored carefully. If the soil appears dry, the filling frequency may need to be increased. If too wet (or if excess water is leaking from the bottom of the container), the filling frequency should be decreased. Watch the relative health of the main plant for signs of stress. Top water the underplantings as required until their roots have made it to the moisture zone, typically 1-3 weeks.

After several weeks the water needs of the plants and the soil moisture levels should gradually stabilize, and a regular schedule can be established. Remember that the plants' water needs may change with the seasons or weather, and that the refilling interval may need to be changed accordingly.

## Troubleshooting

Overwatering, damp soil or excessive drainage— check to make sure the sensor is planted in soil, and attached to the sensor module, and that the stopper is tightened on the fill tube after each fill. If necessary, the sensor may be buried deeper, and fill the reservoir less frequently.

Underwatering, or dry soil—It may be necessary to raise the sensor in the container, or in the case of underplantings, water in longer to establish roots. It may also be useful to fill the reservoir more frequently.

## Maintenance

### Winterizing the CWM Modular System

Because the CWM system is insulated by the surrounding soil, relatively little is required for winterization. Ideally the system will be empty by the first hard frost.

To accomplish this, begin decreasing the refilling frequency as Fall approaches, and stop entirely prior to the first hard frost. Because of the nature of the materials used in constructing the CWM, it isn't necessary to have the reservoirs completely empty.



**Tournesol**  
SITEWORKS

### **Tournesol Siteworks Limited Three-Year Warranty**

Tournesol Siteworks, Inc. warrants to the initial purchaser of its products that they will repair or replace product that contains a defect in material or workmanship for a period of three years from the date it is delivered to the initial purchaser.

This limited warranty does not include those parts which fall under standard regular maintenance of the planter, including but not limited to parts which are subject to periodic replacement. The warranty does not apply to conditions resulting from misuse, abuse, failure to follow directions for use, unauthorized modifications, neglect, accident or other hazard or the like. ***The remedy under this warranty is limited to repair or replacement, at Tournesol Site-works's option, of the defective parts of the warranted product.*** Repair or replacement of a part does not extend the warranty beyond the initial warranty period.

This is the only written warranty applicable to the product. The duration of the implied warranty on the product is limited to the three year duration of this express warranty. ***In no event shall Tournesol Siteworks be liable for any incidental or consequential damages, including but not limited to damage to any plants which may have been planted in the product.*** Some states do not allow limitations on how long an implied warranty lasts or the exclusion or limitation of incidental or consequential damages, so the above limitations or exclusions may not apply to you. This warranty gives you specific legal rights and you may also have other rights which may vary from state to state.

For service or if you have any questions or problems, please contact:

### **Tournesol Siteworks LLC**

Hayward, CA  
800.542.2282

[www.tournesolsiteworks.com](http://www.tournesolsiteworks.com)